

Barnstormer

USA Sunday Fighter

CONSTRUCTION MANUAL

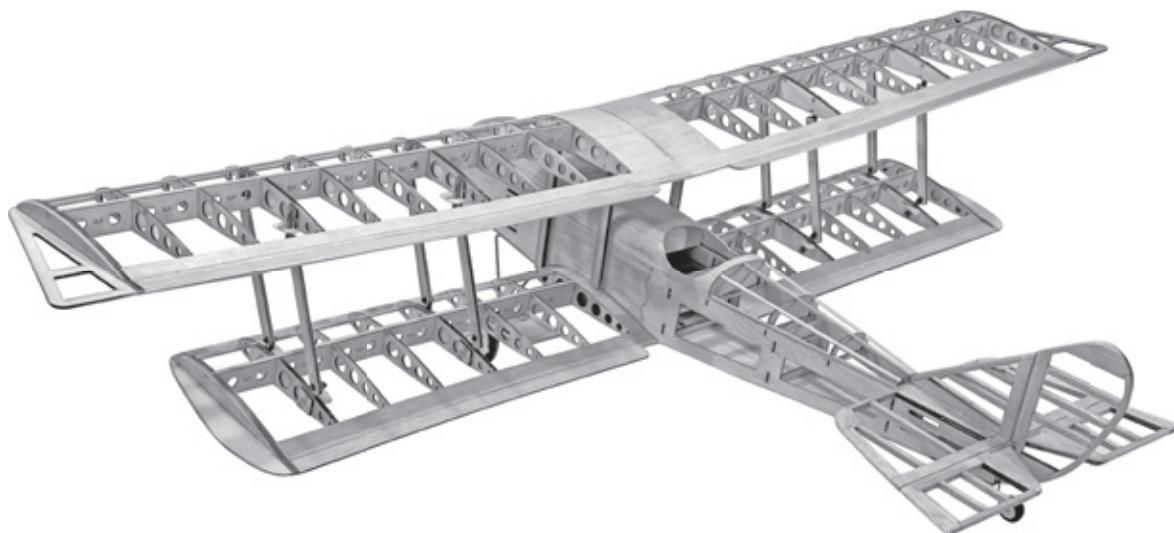

Specifications: Wingspan: 59.6 in. • Wing Area: 863 sq in.
Airframe Length: 34 in. • Weight: 3.5 - 4 lbs. (ready to fly)

Using the Manual

Be sure to read each step thoroughly before you start the step. Test-fit the parts together to make sure they fit properly. If necessary trim to fit.

Beside each step you will notice a check box (or two). These are so you can keep track of your progress while building your kit. For steps that have two boxes, as in the construction of the left and right wing halves, these steps must be performed at two different times.

- Your **Old School Model Works** aircraft should not be considered a toy, but rather a sophisticated, working model that functions very much like a full-size airplane. Because of its performance capabilities, this model, if not assembled and operated correctly, could possibly cause injury to yourself or spectators, and damage to property.
- You must assemble this model according to the instructions. Do not alter or modify this model, as doing so may result in an unsafe or un-flyable model. In a few cases the instructions may differ slightly from the photos. In those instances the written instructions should be considered as correct.
- You must take time to build straight, true and strong.
- You must use a R/C radio system that is in first-class condition, a correctly sized power system and components (electronics, batteries, wheels, etc.) throughout the building process.
- You must correctly install all R/C and other components so that the model operates correctly on the ground and in the air. (Installation shown in the manual is a suggestion. You may have to adjust the mounting steps to accommodate the size of your radio equipment.)
- You must check the operation of the model before every flight to insure that all equipment is operating and that the model has remained structurally sound. Be sure to check clevises or other connectors often and replace them if they show any signs of wear or fatigue.



- If you are not an experienced pilot or have not flown this type of model before, we recommend that you get the assistance of an experienced pilot in your R/C club for your first flights. If you're not a member of a club, your local hobby shop has information about clubs in your area whose membership includes experienced pilots.
- While this kit has been flight tested to exceed normal use, if this model will be used for extremely high stress flying, such as racing, or if a power system larger than one in the recommended range is used, the modeler is responsible for taking steps to reinforce the high stress points and/or substituting hardware more suitable for the increased stress.

Remember: Take your time and follow the instructions to end up with a well-built model that is straight and true.



www.oldschoolmodels.com

WARNING

READ THROUGH THIS MANUAL BEFORE STARTING CONSTRUCTION. IT CONTAINS IMPORTANT WARNINGS AND INSTRUCTIONS CONCERNING THE CONSTRUCTION AND USE OF THIS MODEL.

A Radio-Controlled aircraft is not a toy! If misused, it can cause serious bodily harm and damage to property. Fly only in open areas, preferably at AMA (Academy of Model Aeronautics) approved flying sites, following all instructions included with your radio, powerplant, electronics and batteries.

- Inspect your model before every flight to ensure it is airworthy.
- Be aware of any other radio frequency user who may present an interference problem.
- Always be courteous and respectful of other users in your selected flight area.
- Choose an area clear of obstacles and large enough to safely accommodate your flying activity.
- Make sure this area is clear of friends and spectators prior to launching your aircraft.
- Be aware of other activities in the vicinity of your flight path that could cause potential conflict.
- Carefully plan your flight path prior to launch.
- Abide by any and all established AMA National Model Aircraft Safety Codes.

IMPORTANT!!! Two of the most important things you can do to preserve the radio controlled aircraft hobby are to avoid flying near full-scale aircraft and avoid flying near or over groups of people.



WARNING: This product can expose you to chemicals including lead, which is known to the State of California to cause cancer and birth defects or other reproductive harm. For more information go to www.P65Warnings.ca.gov.

INCLUDED ITEMS

Wood parts included in this kit:

- 1 - LP1 - Laser Cut 1/8" x 6" x 24" ply sheet
- 1 - LP2 - Laser Cut 1/8" x 6" x 24" ply sheet
- 1 - LP3 - Laser Cut 1/8" x 6" x 24" ply sheet
- 1 - LP4 - Laser Cut 1/8" x 6" x 24" ply sheet
- 1 - LP5 - Laser Cut 1/8" x 6" x 24" ply sheet
- 2 - LP6 - Laser Cut 1/8" x 1.6" x 24" ply sheet
- 1 - LP7 - Laser Cut 1/16" x 3" x 11" ply sheet
- 1 - LP8 - Laser Cut 1/8" x 1.6" x 24" ply sheet
- 1 - LP9 - Laser Cut 1/8" x 4" x 8" ply sheet
- 2 - BP1 - Laser Cut 1/8" x 4" x 12" balsa sheet
- 2 - BP2 - Laser Cut 1/8" x 4" x 12" balsa sheet
- 1 - BP3 - Laser Cut 1/8" x 4" x 24" balsa sheet
- 2 - BP4 - Laser Cut 3/32" x 4" x 24" balsa sheet
- 2 - BP5 - Laser Cut 3/32" x 4" x 24" balsa sheet
- 1 - BP6 - Laser Cut 3/32" x 4" x 24" balsa sheet
- 1 - BP7 - Laser Cut 3/32" x 4" x 24" balsa sheet
- 1 - BP8 - Laser Cut 3/32" x 4" x 24" balsa sheet
- 1 - BP9 - Laser Cut 3/32" x 4" x 24" balsa sheet
- 4 - BP10 - Laser Cut 1/16" x 4" x 24" balsa sheet
- 1 - BP11 - Laser Cut 1/16" x 4" x 24" balsa sheet

- 4 - 1/16" x 4" x 12" balsa sheets (uncut)
- 1 - 1/16" x 4" x 36" balsa sheet (uncut)

- 1.5 - 1/4" x 1/2" x 36" balsa strips
- 5 - 1/4" x 1/4" x 36" balsa strips
- 10 - 1/8" x 1/8" x 36" balsa strips
- 4 - 3/16" x 3/16" x 36" balsa strips
- 4 - 3/16" x 3/16" x 24" basswood strips
- 4 - 3/16" x 3/16" x 36" basswood strips
- 3 - 1/8" x 12" dowels

Hardware parts included in this kit:

- 1 - Pre-bent landing set (left & right)

- C/A type hinges for control surfaces
- 4 - control horns
- 2 - wheel collars 1/8" I.D.
- 2 - 1/4 x 20 x 2" wing bolts
- 10 - 2-56 x 1/2" machine screws
- 20 - 2-56 x 3/4" self tapping screws
- 4 - plastic landing gear straps
- 20 - 4-40 x 1/2" socket head cap screws
- 20 - 4-40 t-nuts (blind nuts)
- 20 - strut straps
- 8 - 1/4" x 1/8" neodymium magnets
- 1 - 1/4" x 6" wooden dowel

Other items included in this kit:

- 2 - Rolled plans (1 fuselage and 1 wing)
- 1 - Construction manual
- 1 - Plastic windscreen
- 1 - Plastic scoop/louvers
- OSMW sticker sheet

ITEMS NEEDED

Hardware needed (not included in the kit)

For some of these items there is more than one option which will require a bit of decision making ahead of time. There isn't a right or a wrong choice, so choose the items that work best for you. Resist the urge to overpower your Sunday Fighter and remember that it is not against the law to practice proper throttle management.

Here is a list of additional parts needed to complete and fly this kit, all of which must be purchased separately. Again, we would recommend supporting your local hobby shop.

- Powerplant:
 - Glow (.20-.30 engine, fuel tank, fuel tubing)
 - Electric (equivalent brushless motor, ESC, & 3S Lipo)
- Propeller

- Engine/Motor mount and mounting hardware
- Receiver - (4 channel minimum)
- 2-5 servos depending on setup: 2 mini for elevator/rudder, 2 Sub-Micro for ailerons/throttle
- "Y" servo harness and aileron servo wire extensions.
- Pushrods (two 5" for ailerons, two 20" for elevator & rudder, one 10" for throttle if glow/gas powered)
- Clevises for the pushrods (8 if electric, 10 if glow).
- 2 - 3.5" diameter wheels.
We suggest Du-Bro's # 350V vintage style wheels.
- 1 - tailwheel assembly
- Covering - 2-3 rolls

Additional Required Building Tools and Adhesives

- Drill & assorted drill bits
- Hobby knife and new, sharp blades
- Sandpaper: coarse (80 or 100 grit) & medium (150-200 grit)
- Pencil or pen
- Ruler
- String (two 18" lengths)
- T-Pins
- Waxed paper
- Building board
- Adhesives of your choice. We recommend thin and medium CA (cyanoacrylate) viscosities, 15 or 30 minute epoxy, and canopy glue
- Epoxy brushes and mixing sticks
- Thread-locking compound

Before Starting Assembly

Closely inspect the supplied laser cut parts for damage. If you find any damaged or missing parts, contact us within 60 days from purchase.

When removing the laser cut parts from their sheets, you'll notice the parts are held in place by several small "tabs". These tabs are uncut pieces of wood and can sometimes make it difficult to remove a part. Rather than breaking and/or splintering the wood by forcing out the part, we recommend removing any laser cut parts from their sheets by using a hobby knife with a new, sharp blade. A quick cut of the tab will allow the piece to be removed with no damage. Sand any tab remainders flush with the part so there will be no problem aligning them later.

It's best to not remove parts from their sheets until they are needed. Refer to Appendix A of this manual as a reference to what all the laser cut parts look like and are called.

For each step, we highly recommend that you dry fit the parts in each step first. Lightly sand as needed to ensure a good fit. Once you're satisfied with the fit, then and only then, glue the parts in position.

IT IS VERY IMPORTANT THAT YOU ASSEMBLE THIS KIT IN THE ORDER DESCRIBED. SKIPPING FORWARD IN THE STEPS COULD LEAVE YOU WITHOUT THE PROPER LENGTHS OF WOOD TO FINISH THE KIT. WE'VE INCLUDED ENOUGH WOOD TO EASILY COMPLETE THIS KIT, BUT YOU MUST TAKE CARE TO PROPERLY MEASURE AND NOT WASTE WOOD WHEN CUTTING.

A FEW THOUGHTS BEFORE YOU START.

Our Sunday Fighter series was inspired by a design penned by Ken Willard in the March 1974 issue of American Aircraft Modeler. His were smaller with .049 power, based on the Ace Foam Wings available at the time.

This version has a lot of Curtiss Jenny in it - so that's why we call this one the Barnstormer.

We've enlarged his original for .25 sized powerplants or for equivalent electric with typical 3S 2200mAh LiPo packs that you probably already have on hand.

Ken never intended for these to be anything other than a design that is a blast to fly on the weekends, flying for fun, and even competing with them in club fun-fly events.

We're very much in line with this way of thinking. We see our version of the Sunday Fighter as "stand way off and squint at it with only one eye" scale. If you like, it can be made to resemble several different designs with simple color scheme modifications. Or if you're a bit more inspired, it's a blank canvas where you can use your imagination to modify it into the biplane you'd like.

One last thing. Please, please, please resist the urge to overpower these bipes. Yes, the airframe can stand up to a lot of abuse, but these are NOT 3D machines. Vintage designs like these should NEVER be seen hovering, flying inverted for long periods of time, or anything related to pylon or IMAC flying.

Just have fun cruising and barnstorming, and maybe pretend you're the star of an old-time airshow act. "Step right up, folks, and look to the skies.....!?"

Online Supplementary Photos

We realize that the smaller black-and-white photos in this manual might not show some of the steps as clearly as you might want. So we've anticipated this and made these photos available on our website. You can either scan the QR code or type this address into your browser:



www.oldschoolmodels.com/mpics/sfu/

IMPORTANT!!!!
THERE ARE SEVERAL STEPS THROUGHOUT THE BUILD OF YOUR SUNDAY FIGHTER WHERE PIECES NEED TO BE CUT FROM LEFT-OVER (SCRAP) WOOD.

AS YOU TRIM THE SHEETS/STICKS INCLUDED IN THIS KIT, PLEASE KEEP ALL SCRAP WOOD IN A SEPARATE PILE AS YOU'LL NEED SOME OF IT.

Let's begin construction by working on the Sunday Fighter's top, port (left) wing.

Step 1 - Alignment triangles

Pre-cut into LP3 is a triangle that can be used to vertically align any of the parts in the construction of your Sunday Fighter. LP3 also includes a foot piece that can be used with the triangle to hold it vertically, hands-free.



We recommend using this triangle throughout the wing construction, and in the alignment of the vertical fin.

Step 2 - Prepare your work area

You'll need a flat building surface that is a minimum of 32" long. Position the top, port wing plan over the surface and tape into position. Tear off a length of waxed paper long enough to cover the plan and tape that into position, over the plan.

Step 3 - Top Wing Assembly (lower spar)

Locate one of the 3/16" x 3/16" x 36" basswood strips. This will form the lower spar. Position it over the plan, measure and cut to length, leaving about a 1/4" extra on each end. We prefer to tack-glue this piece to the waxed paper, holding it in place using a few small drops of medium CA, instead of t-pins. Be sure it is aligned properly and is straight over its entire length. The alignment of this spar is critical as the rest of the wing panel is based off this piece.



Cut into BP10 are SPC pieces. Use two of these as shown here, to raise the spar off the board, **ONLY** where the spar intersects R3 and R1.



Step 4 - Top Wing Assembly (R9 & SW4)

Locate one R9 from BP4/6/9 and one SW4 from BP10.

We find it easiest to glue SW4 to R9 first with a touch of thin CA; making sure it's at 90° and it's tab fully inserted into the pre-cut slot in the rib.

Then glue R9 in place on over the plans as shown, making sure the rib is completely pushed down, onto the spar.



SW4 is the same height as R9 so when it is resting on the building surface it should be holding R9 perfectly vertical.

Step 5 - Top Wing Assembly (R9 & SW4)

Locate two R9s from BP4/6/9 and two SW4s from BP10.

Using the same technique as before, glue these rib/web assemblies together, then in place as shown.

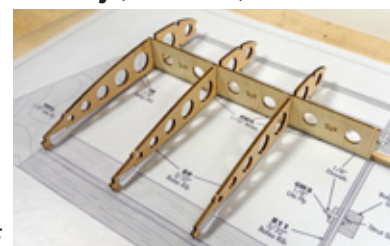

For this step, and each of the following steps that involve attaching ribs and shear webs, take the extra time to make sure that tab(s) from the already installed shear web are completely inserted into the rib you're about to glue in place. Any gaps will cause alignment errors as you go further into the wing's build, and several of these gaps can lead to a longer than wing than designed.

Step 6 - Top Wing Assembly (R11 & SW4)

Locate one R11 from BP4/6/9 and one SW4 from BP10.

These are glued in place as shown, making sure all the tabs are completely inserted into the slots.



Step 7 - Top Wing Assembly (R9 & SW4)

Locate two R9s from BP4/6/9 and two SW4s from BP10.

Using the same technique as before, glue these pieces in place as shown.



Step 8 - Top Wing Assembly (R11 & SW4)

Locate one R11 from BP4/6/9 and one SW4 from BP10.

These are glued in place as shown, making sure all the tabs are completely inserted into the slots.

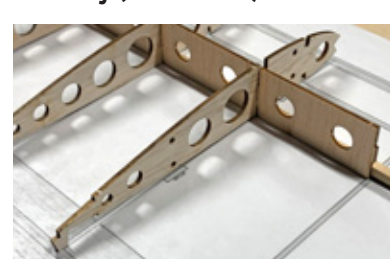

□ □ Step 9 - Top Wing Assembly (R9 & SW4)

Locate one R9 from BP4/6/9 and one SW4 from BP10. Using the same technique as before, glue these pieces in place as shown.

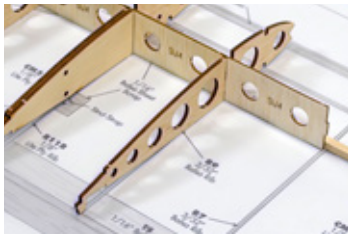

□ □ Step 10 - Top Wing Assembly (R7 & SW3)

Locate one R7 from BP4 and two SW3s from BP10. This time two sheer webs are glued to R7, then glued to the rib as shown here. Again, make sure the sheer web's tabs are completely inserted into the slots.

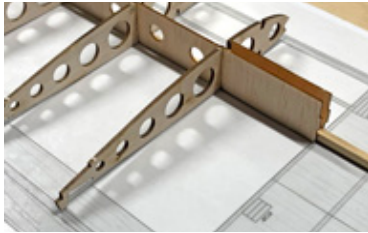

□ □ Step 11 - Top Wing Assembly (R5 & SW2)

Locate one R5 from BP4 and two SW2s from BP10. Again the two sheer webs are glued to R5, then glued to the rib as shown here. Make sure the sheer web's tabs are completely inserted into the slots.

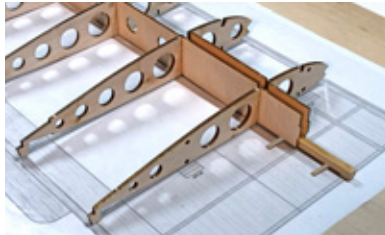

Note that this R5 and SW2 will NOT contact the building surface around the spar area. It is purposely cut 1/16" shy to allow for center sheeting that will be installed later on. When properly positioned, the rib's bottom cutout will be fully inserted on to the lower spar and the sheer webs will rest on the SPC piece that is positioned to bump up the lower spar in this area.

□ □ Step 12 - Top Wing Assembly (R3 & SW1)

Locate one R3 from BP4 and two SW1s from BP10. Note that the SW1's have a small circle engraved in a corner. This designates the edge that will be glued to the root rib, and the circle should be on the top when installed. Glue both SW1s to R3, and then to the rib as shown here. Again, make sure the sheer web's tabs are completely inserted into the slots.

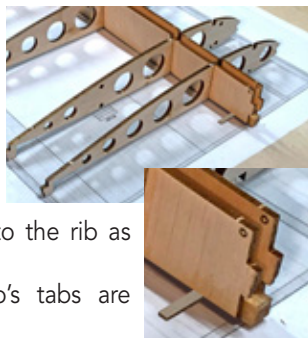

□ □ Step 13 - Top Wing Assembly (R1)

Locate one R1 from LP2. Also locate the DH-JIGs from LP3. The DH-JIG pieces are used as a guide to ensure that R1 is glued in at the correct angle. You'll use these on for each of the Sunday Fighter's wing halves so save them for future use. Test fit R1 in place as shown. When properly fitted, the angles of the SW1's will allow R1 to slant in at a 2.5° angle. Verify this with the DH-JIG. When satisfied, glue R1 in place.



□ □ Step 14 - Top Wing Assembly (trailing edge)

Locate one of the 3/16" square balsa strips. This is used as the wing's trailing edge.



Measure and cut to length, leaving about 1/4" extra on each end. Glue this in place, making sure it is securely glued to the rear of each rib, and that each rib is properly aligned. Using a long straight-edge can help holding everything in place, firmly against the building surface.

□ □ Step 15 - Top Wing Assembly (leading edge)

Locate one of the 1/4" square balsa strips. Measure and cut to length, leaving about 1/4" extra on each end.



Glue this in place, making sure it is securely glued to the front of each rib, and that each rib is properly aligned. Using a long straight-edge can help holding everything in place, firmly against the building surface.

□ □ Step 16 - Top Wing Assembly (upper sub-spar)

Locate one of the 1/8" square balsa strips. Measure and cut to length, leaving about 1/4" extra on each end.



Glue this in place, making sure it is securely glued to into the pre-cut notch of each rib, and that each rib is properly aligned. Note that this piece will "dip" when gluing to the pre-cut slots in R5, R3 and R1. This is to allow for the wing's center sheeting. So make sure this strip is fully inserted into the slots of each and every rib.

□ □ Step 17 - Top Wing Assembly (create dihedral box)

Now it's time to cut-away the center of two ribs - R3 and R5. Here are the before and after photos to help show what needs to be done.



Make sure that the area is completely clean and smooth, as later on this will be a channel where the dihedral brace will slide through. The cleaner it is now, the easier it will be to slide in the brace when it's time.

Before cutting

After cutting

Take your time and use a gentle touch in this step as you don't want to cut more than you should, nor do you want to damage the sheer webs in these spots as it could weaken the wing or cause a misalignment.

□ □ Step 18 - Top Wing Assembly (upper spar)

Locate another 3/16" x 36" square basswood strip to use as the upper spar. It will need to be trimmed to length, but leave it slightly oversized so it extends roughly 1/8" past R1 and ends at the outer edge of R9. Glue this in place, making sure it is securely attached to each rib and completely pushed into the pre-cut slots of each rib.



As with the 1/8" sub-spar attached a couple steps back, this basswood strip will need to "dip" when gluing to the pre-cut slots in R5, R3 and R1. This is to allow for the wing's center sheeting. So make sure this strip is fully inserted into the slots of each and every rib.

□ □ Step 19 - Top Wing Assembly (top, rear sheeting)

Locate the uncut 1/16" x 4" x 36" sheet. Measure and cut a 3/4" x 36" strip from this sheet. This strip is trimmed to length and glued in place as shown, along the rear of the ribs and butting up against the trailing edge strip.



Again, using a long straight-edge can help hold down this strip while gluing.

□ □ Step 20 - Top Wing Assembly (top, center sheeting)

Included in your kit are uncut 1/16" balsa sheets and extra sheeting on the BP10 sheets. These are used when sheeting the center section of the wings, as well as a few points on the fuselage.



Carefully measure and cut a few pieces of sheeting to cover the R1, R3 and R5 ribs, as shown on the plans.

When measuring, make sure that the grain is crosswise (flowing from R1 to R5).

When edge gluing the sheeting pieces together, first make sure the edges are flat (give a quick, swipe or two with a sanding block).

Then tape the two pieces together as shown here with a piece of tape. As you lift the sheeting from the board you'll see that the tape will act as a hinge allowing you to put a small amount of adhesive in the joint. When the adhesive is applied, place the sheeting back



down on the waxed paper, so that it's flat (as shown in the photo). When cured, you'll now have a single, longer piece of sheeting. You'll need to join a few pieces together to form a piece long enough to reach from the leading to the trailing edge.

Test fit the piece to the wing. If you're having trouble getting the leading edge portion of the sheet to bend, squirt it a few times with original Windex® window/glass cleaner. The ammonia mixed into the solution will relax the wood fibers and allow them to bend much, much easier. The wood must be dry for it to properly glue, so you can wait for it to dry, or dry it quickly with a blow-dryer or even a covering heat-gun. Take care to keep your fingers out of the line of fire!

It's easier to join the shorter lengths of sheeting together on a flat surface, then when the glue has cured, trim and glue the sheeting in place on the wing. Start at the leading edge and gluing a little at a time. Press the sheeting firmly against the ribs and wait for the glue to cure before gluing the next section of sheeting - slowly working your way back to the trailing edge, being careful not to put a bend (warp) in the wing.

□ □ Step 21 - Top Wing Assembly (R11B/R5B)

Locate two R11Bs from LP4/5 and one R5B from LP5. These pieces reinforce the back portion of three ribs - R11 and R5. Fit and glue these in place against their respective ribs as shown on the plan (R11B to R11 and R5B to R5). Each should be glued to the inside surface (the surface of the rib that faces the R1 root rib).

No photos are available for this step as this upgrade was made after our photo shoot.

When finished, carefully remove the wing half from the building board. Take some care as it will be a semi-flexible structure at this moment. Don't worry of any of the back tabs snap off as you'll be trimming those away in a few steps.

Turn the wing half over as we'll start work on the underside of the wing next.

□ □ Step 22 - Top Wing Assembly (1/8" dowel pins)

Locate the lengths of 1/8" dowel. Measure and cut this into individual 1" lengths that will be used as pins in the wing construction. You'll need 10 of them for this wing half.



Round the ends slightly to help aid when inserting them into the holes in the following steps. They may also need to be sanded as sometimes although claim to be 1/8", they are often oversized.

□ □ Step 23 - Top Wing Assembly (CM3 & CM4)

Locate two CM3s and one CM4 from LP1 or LP2 (I know it show three, but only two for the included straps).



Glue the CM3s together, stacked on top of each other. Make sure that these are perfectly aligned before the glue cures.

□ □ Step 24 - Top Wing Assembly (CM3 & CM4 assemblies)

Insert two of the dowels half-way into the CM3 assembly, and two more half-way into CM4. Glue these dowels in place.

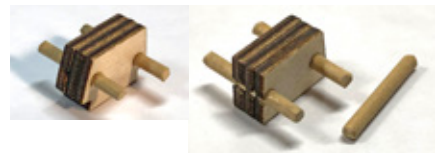

□ □ Step 25 - Top Wing Assembly (CM3 assembly)

Before you install the CM3 assembly in the wing, a couple things to do first.

First, locate one of the wing straps from the hardware bag.

Note that the shape of the CM3 assembly and it's pre-cut holes. As we'll be working from the underside of the wing, the more "curved" surface will be oriented downward in this step. This allows the holes in CM3 and in R3 to be lined up.

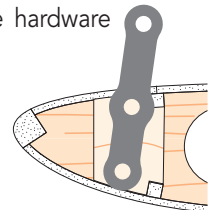

Carefully push the two dowels in the CM3 assembly into the pre-cut holes in R3. Make sure this is on the proper side of the rib (the side facing the root rib). Glue this to R3.



□ □ Step 26 - Top Wing Assembly (CM3 assembly)

Now slide the strap in place, gluing it to the CM3 assembly. Locate one more of the CM3's from LP1 or LP2. Slide the CM3's on the rib side only and glue it in place to "sandwich" and strengthen the rib. (Ignore the extra CM3 shown in this photo.)

□ □ Step 27 - Top Wing Assembly (CM4 assembly)

The CM4 assembly is installed similarly to the CM3 you just installed.

Install the CM4 assembly, paying attention to the orientation and making sure it's glued to the same face of R5.

Locate another strap, and one CM4 from LP1 or LP2, and glue it on the rib side to lock everything in place.

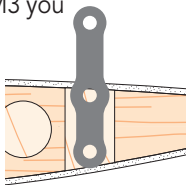

□ □ Step 28 - Top Wing Assembly (tab removal)

Now it's time to remove the tabs from the bottom of the trailing edge. These should be carefully cut away, then sanded so they allow the continuation of the airfoil's shape.

Because R1 is made from ply, we found it easiest to first use a pair of side-cutters or a saw to remove the majority of the tab, then sand.

□ □ Step 29 - Top Wing Assembly (lower, rear sheeting)

Cut and trim another 3/4" x 36" strip from the uncut 1/16" sheet you used earlier. This strip is glued in place as shown, along the rear of the ribs and butting up against the trailing edge strip.

Again, using a long straight-edge can help hold down this strip while gluing.



□ □ Step 30 - Top Wing Assembly (lower sub-spar)

Next, locate another of the 1/8" square balsa strips. Measure and cut to length, leaving about 1/5" extra on each end. Glue this in place, making sure it is securely glued into the pre-cut slots of each rib.

Note that this piece will "dip" when gluing to the pre-cut slots in R5, R3 and R1. This is to allow for the wing's center sheeting. So make sure this strip is fully inserted into the slots of each and every rib.



□ □ Step 31 - Top Wing Assembly (rear center section)

Using more of the 1/16" balsa sheeting, now you will measure, cut and glue in the lower, center sheeting as shown here.

Use the same techniques as you did when installing the upper sheeting back in step 20. The only difference here is that you'll also have to mark and cut two small openings where the straps will protrude.



□ □ Step 32 - Top Wing Assembly (CM1 assembly)

Locate two CM1s from LP1, two of the 1/8" dowels you cut earlier and one strap.

Push the two dowels halfway into the holes in CM1.

Now note the curvature of CM1 as the more "curved" surface will be oriented downward.

Carefully push the two dowels in the CM1 assembly into the pre-cut holes towards the front of R11. Make sure this is on the proper side of the rib (the side facing the root rib). Glue this to R11. Then glue the other CM1 in place on the other side of the rib. Glue the strap in place.

Then locate two more CM1s, two 1/8" dowels and another strap - these will be made up the same way and glued into the front part of the other R11.

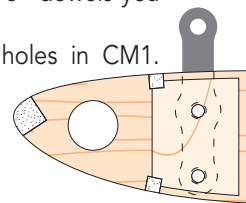

□ □ Step 33 - Top Wing Assembly (CM2 assembly)

Locate one CM2 from LP2, two of the 1/8" dowels you cut earlier and one strap.

Push the two dowels halfway into the holes in CM2.

Now note the curvature of CM2 as the more "curved" surface will be oriented downward.

Carefully push the two dowels in the CM2 assembly into the pre-cut holes towards the rear of R11. Make sure this is on the proper side of the rib (the side facing the tip rib). Glue this to R11.

Glue the strap in place.

Then locate another CM2, two 1/8" dowels and another strap - these will be made up the same way and glued into the rear part of the other R11.

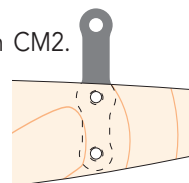

□ □ Step 34 - Top Wing Assembly (TR and TTIP)

Before this step, take a minute to sand any of the spars, leading and/or trailing edge wood that extend past R9, as you'll need a flat face for this step.

Locate one TR from BP1/2 and one TTIP from LP4/5.

Glue the TR to the flat surface of R9 on the outer tip of the wing, making sure it is properly aligned with R9.

Then glue TTIP in place as shown, making sure it is level with the wing.



□ □ Step 35 - Top Wing Assembly (R1 cutout)

The last step in this half of the top wing is to mark and cutout a slot in R1. This will be a rectangle and is positioned between the upper and lower spars, as well as the front and rear shear webs. Refer to this drawing as a guide.

Use a rotary tool for the main portion, then a sharp hobby knife for the corners. Take care not to damage the balsa shear webs or weaken the spars.

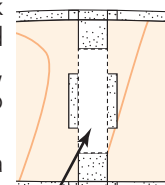

Cut out this area from R1

Set the top port wing half aside and begin work on the top starboard (right) wing half. Tape the right wing plan and fresh wax paper on your board. Then follow steps 1 through 35 to complete the starboard wing half. Once finished, then move on to step 36.

Note that when building the starboard half that many of the parts will need to be glued to the opposite side (the sheer webs, for instance). Always refer to the plans to make sure you're gluing the parts together in the correct way.

**This completes the sub assemblies of the top wing.
Now you'll assemble the bottom wing halves.**

Step 36 - Bottom Wing Assembly

The bottom wings are largely constructed in the same way as the top wings. The rib numbers are different, but the general construction is the same. Build both wing halves using the same techniques as you did on the top wing, steps 1-18, then come back to step 37 for the steps unique to the bottom wing halves.

Start with the lower spar, then add the ribs and sheer webs from the tip, into the root. Add the lite ply R10Bs to the inner surface of both R10.

Trailing and leading edge is next, followed by the upper-sub spar. Finish up by cutting the ribs for the dihedral box and adding the upper spar.

Step 37 - Bottom Wing Assembly (WH1)

Locate one WH1 from LP4. This is inserted into the rear notches cut into R2 and R4.

Glue this in place, making sure it is firmly seated into both slots.



Step 38 - Bottom Wing Assembly (top, rear sheeting)

Locate one of the pre-cut strips of wing sheeting from BP11. One of these strips is glued in place as shown, along the rear of the ribs and butting up against the trailing edge strip.

Before you glue it in place, you'll need to cut a notch to fit around WH1 you just installed.

Again, using a long straight-edge can help hold down this strip while gluing.



Step 39 - Bottom Wing Assembly (top, center sheeting)

Using more of the 1/16" balsa sheeting, now you will measure, cut and glue in the upper, center sheeting as shown here. Use the same techniques as you did when installing the upper sheeting back in step 20.

When cured, remove this wing half from the building surface.



Step 40 - Bottom Wing Assembly (tab removal)

Now it's time to remove the tabs from the bottom of the trailing

edge. These should be carefully cut away, then sanded so they allow the continuation of the airfoil's shape.

Because R2 is made from ply, we found it easiest to first use a pair of side-cutters or a saw to remove the majority of the tab, then sand.

Step 41 - Bottom Wing Assembly (WH2 & WH3)

Locate WH2 from LP4 and two WH3 from LP3. Before you glue WH2 in place, first glue both WH3s in place, on either side of the pre-cut hole in WH2. Also make sure that you glue WH3s in the correct orientation. We recommend dry fitting these together first.



When satisfied that everything is aligned properly, glue these pieces in place. When properly placed, the etched circle should be closest to R2 as shown.



Step 42 - Bottom Wing Assembly (lower rear sheeting)

Locate another of the pre-cut strips of wing sheeting from BP11. One of these strips is glued along the rear of the ribs and butting up against the trailing edge strip.

Before you glue it in place, you'll need to cut a notch to fit around WH2 you just installed.

Again, using a long straight-edge can help hold down this strip while gluing.

Step 43 - Bottom Wing Assembly (lower, center sheeting)

Using more of the 1/16" balsa sheeting, now you will measure, cut and glue in the lower, center sheeting. Use the same techniques as you did when installing the upper sheeting.

Step 44 - Bottom Wing Assembly (CM5 assembly)

Locate four CM5's from LP2/4/5, two of the 1/8" dowels you cut earlier and one strap.

The CM5's are glued in place, one on each side of both R10s, making sure to align them properly. Glue the two dowels half-way into the R10/CM5 assembly, then glue the strap in place, making sure it is on the proper side (inside) of the rib.

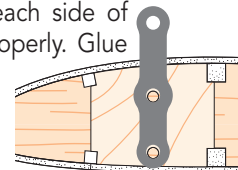

Step 45 - Bottom Wing Assembly (CM6 assembly)

Locate one CM6 from LP2, two of the 1/8" dowels you cut earlier and one strap.

Slide the two dowels half-way into CM6, then glue this into place, on the back part of R10. It should be glued to the outer side (balsa side). Then glue the strap in place on the inner side of R10B.

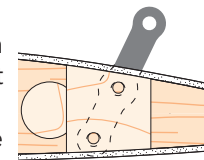

Set the bottom wing half aside and begin work the opposite half of the bottom wing. Follow steps 36 through 45 to complete the other wing half. Once finished, then move on to step 46.

Note that when building the starboard half that many of the parts will need to be glued to the opposite side (the sheer webs, for instance). Always refer to the plans to make sure you're gluing the parts together in the correct way.

Step 46 - Bottom Wing Assembly (aileron servo hatch)

Now, before you construct the aileron servo bays, you need to make a decision.

Your Barnstormer can be made with lower ailerons only (like we used in our prototypes). You can use upper ailerons only (to sort-of mimic the full-scale Curtiss Jenny), or you can use ailerons on the top and bottom wings. Note: found no advantage in using anything other than bottom ailerons on our prototypes.

The construction of the aileron servo bays are the same, regardless of the direction you choose.

- If you choose bottom ailerons only, or both top and bottom ailerons, the aileron servo bays will be built into the bottom wing as shown on the plans.
- If you're going top ailerons only, the servo bays will be built into the top wing only, between the two R9 ribs, roughly in the center of each top wing panel. **You'll need to substitute this in your mind as this step shows the bottom wing installation only.**

Locate one SH from LP3 (SHP is for the port side, SHS for starboard). Also locate some of the scrap 3/16" basswood strip from trimming the spars.

Cut two lengths of basswood that are a 1-7/8" long. These will be the mounting rails for the hatch.

Fit the SH in place, on the underside of the appropriate wing half between the two R6 ribs. Push it up against the sheer web and tape in place so it is flush with the bottom of the ribs.



Now lay the two basswood rails in place as shown, on either side of the hatch. Lightly tack these in place with a few drops of glue. When secured, remove the hatch and finish gluing the rails more securely in place.

Lastly, measure and cut a length of scrap 1/4" square balsa to form the back portion of a "frame" that the hatch will fit into. Glue it between the ribs, flush with the bottom edges, and up against the hatch - but don't glue it to the hatch.

Step 46 - Bottom Wing Assembly (R2 cutout)

Just as you did for the top wing halves, it's time to mark and cutout the slots in R2 to accept the dihedral braces. These are rectangles and is positioned between the upper and lower spars, as well as the front and rear sheer webs.

Use a rotary tool for the main portion, then a sharp hobby knife for the corners. Take care not to damage the balsa sheer webs or weaken the spars.

Step 47 - Wing Assembly (sanding)

Sand the tip and root ribs of all four wing halves to remove any extra spar and sheeting material. Make sure they have smooth, flat surfaces. Attach TR and BTIP to each tip rib, as you did on the upper wing.

Step 48 - Wing Assembly (DH1/DH2)

Locate two DH1's from LP1 and four DH2s from BP10. These pieces are laminated together with a thin layer of epoxy to form two identical wing dihedral braces.



Two DH2's are glued to each side of each DH1 to form thicker pieces.

Note that there is an etched circle in each DH2 that designates the angled cut. Align these properly so it matches the angle of DH1.

To insure the pieces stay perfectly aligned, clamp or weigh down both assemblies until the glue fully cures.

Step 49 - Wing Assembly (join wing halves)

Now take one of the assembled dihedral braces and test fit into the wing slots of the top wing halves. You will probably have to do a bit of sanding on the brace to allow it to easily fit into each slot. Don't take off too much, too fast. Carefully sand as necessary to make sure everything fits properly and the root ribs in each wing half are touching along their entire length when assembled into a single wing. Take your time and get a good fit that doesn't require a lot of force.

Once you're happy with the top wing's fit, do the same with the bottom wing halves and the remaining dihedral brace assembly.

Step 50 - Wing Assembly (PIN)

Locate both PIN's from LP3. These are anti-rotation pins and are used to help align the rear portion of the wings.



Glue one PIN halfway in the upper port wing half and the other halfway in the lower port wing half.

Step 51 - Wing Assembly (join wing halves)

Test fit the wing halves together one last time and sand as necessary for a good fit.

After test fitting, join the top wing halves permanently with a bit more 30 minute epoxy. Remove the dihedral brace and apply the epoxy into the pockets in each wing half and also coat the faces of each root rib.

Slide all the dihedral brace into one of the wing halves, then slide remaining wing half in place. Using a couple of clamps (or tape), hold wing halves firmly together. Wipe off any excess epoxy and remove the clamps only after the epoxy has fully cured.

Remember, any twist in the alignment of the panels cannot be fixed after the epoxy cures and will lead to a poor flying model.

Set the top wing aside and then do the same to assemble the lower wing.

This completes assembly of the Sunday Fighter wings. Now it's time to start construction of the tail surfaces.

Prepare your work area

Now tape the elevator/stab plan and a fresh piece of waxed paper on your building board.



Step 52 - Horizontal Stab Assembly (trailing edge)

Locate the 1/4" x 1/2" balsa strip and cut a piece to form the trailing edge of the horizontal stab as shown on the plans. Pin this in position, making sure it is straight.



Step 53 - Horizontal Stab Assembly (S2)

Locate both S2s from BP2. These are glued in place in the center of the stab, one on top of the other, resting against the trailing edge pieces. Glue these in place.



Step 54 - Horizontal Stab Assembly (S1)

Locate both S1s from BP1. These are glued in place in the center of the stab, one on top of the other, resting against the S2 pieces you just installed. Glue these in place.



Step 55 - Horizontal Stab Assembly (tips)

Cut both outer tips of the stab from the 1/4" x 1/2" balsa strip you used earlier - one for the left and one for the right. Glue these in place and pin them to hold them while the glue cures.



Step 56 - Horizontal Stab Assembly (S3)

Cut four S3s from BP2. Two are used to create the front corner on each side. Glue one on top of the other, then to the tip piece you just installed. Pay close attention to their orientation.



Step 57 - Horizontal Stab Assembly (leading edge)

Using 1/4" square balsa, measure, cut and glue in the leading edge of the stab. Check your scrap pile to see if you have the proper length first, but if not, use an uncut length.



Step 58 - Horizontal Stab Assembly (bracing)

Using 1/4" square balsa, measure, cut and glue in center bracing of the stab. Check your scrap pile using any possible shorter lengths first before reverting to longer, uncut lengths.



Step 59 - Elevator Assembly (leading edge)

Using 1/4" x 1/2" balsa, measure, cut and pin both leading-edge pieces of the elevator to your building surface. Again, use scrap pieces longer, uncut lengths if possible.



Step 60 - Elevator Assembly (E2)

Locate four E2s from BP2. Two are used to create the inside corners on each elevator half. Glue one on top of the other, then to the leading edge pieces you just installed. Pay close attention to their orientation.



Step 61 - Elevator Assembly (trailing edge)

Using 1/4" square balsa, measure, cut and glue both trailing

edges. Check your scrap pile using any possible shorter lengths first before reverting to longer, uncut lengths.



Step 62 - Elevator Assembly (E1)

Locate four E1s from BP2. Two are used to create the outer corners on each elevator half. Glue one on top of the other, then to the leading edge pieces.



Pay close attention to their orientation.

Step 63 - Elevator Assembly (bracing)

Using 1/4" square balsa, measure, cut and glue in center bracing of both elevator halves. Check your scrap pile using any possible shorter lengths first before reverting to longer, uncut lengths.



Step 64 - Elevator Assembly (joiner)

Locate the 1/4" dowel, then measure, cut and glue it in place to join both elevator halves into a single elevator. Make sure this joint is strong and fully cured before removing it from the work surface.



Prepare your work area

Now tape the rudder/fin plan and a fresh piece of waxed paper on your building board.



Step 65 - Vertical Fin Assembly (trailing edge)

Using 1/4" x 1/2" balsa, measure, cut and pin the trailing edge of the vertical fin to your building surface. Again, use scrap pieces before longer, uncut lengths if possible.



Step 66 - Vertical Fin Assembly (VF1)

Locate two VF1's from BP2. They are used to create the bottom edge of the vertical fin. Glue one on top of the other, then to the trailing edge.



Pay close attention to their orientation.

Step 67 - Vertical Fin Assembly (leading edge)

Using 1/4" x 1/4" balsa, measure, cut and pin the leading edge of the vertical fin to your building surface. Again, use scrap pieces before longer, uncut lengths if possible.



Step 68 - Vertical Fin Assembly (bracing)

Using 1/4" square balsa, measure, cut and glue in center bracing of the vertical fin. Check your scrap pile using any possible shorter lengths first before reverting to longer, uncut lengths.



Step 69 - Rudder Assembly (leading edge)

Using 1/4" x 1/2" balsa, measure, cut and pin both the leading of the rudder to your building surface. Check your scrap pile using any possible shorter lengths first before reverting to longer, uncut lengths.



Step 70 - Rudder Assembly (bottom corner)

Locate both VF4s from BP3. Glue one on top of the other, then to the leading edge - paying close attention to it's orientation.



Step 71 - Rudder Assembly (upper corner)

Locate both VF2s from BP1. Glue one on top of the other, then to the leading edge. Pay close attention to it's orientation.



Step 72 - Rudder Assembly (trailing edge)

Locate both VF3s from BP2. Glue one on top of the other, then to the leading edge. Pay close attention to it's orientation.



Step 73 - Rudder Assembly (bracing)

Using 1/4" square balsa, measure, cut and glue in center bracing of the rudder. Check your scrap pile using any possible shorter lengths first before reverting to longer, uncut lengths.



Remove the rudder from the board, then make a notch in the leading edge to give clearance for the elevator (see plans). Also make a notch in the trailing edge of the horizontal stab to give clearance for the vertical fin's trailing edge. (See plans).

This completes assembly of the Sunday Fighter tail surfaces. Now it's time to start construction of the fuselage.

Prepare your work area

Now a fresh piece of waxed paper on your building board. You'll also need the fuselage plans as a reference. No need to tape them to the board as they're more for reference.

Step 74 - Fuselage Assembly (fuse sides)

Locate both FS3s from BP6 and BP8, and both FS4s from BP7 and BP9.

One FS3 is glued to one FS4 as shown here to form a fuselage side sheet. Then do the same to create the other side sheet.



Make sure the joints are perfectly flat and the top edge of each sheet is perfectly straight while the glue cures.

Step 75 - Fuselage Assembly (F3 & F4)

Locate F4 from LP2 and F3 from LP3. These are glued on top of

each other as shown. Make sure they are perfectly aligned and keep any glue out of the pre-cut slots and holes.



Step 76 - Fuselage Assembly (F5 & TR2)

Locate F5 from LP3 and TR2 from LP1.

Carefully slide F5 into the slots in TR2 as shown. Also pay close attention to the orientation of TR2 as get positioned the correct way.

Glue F5 in place, securely against TR2 and making sure it's a perfect 90° angle (use the triangles we included to help with this).

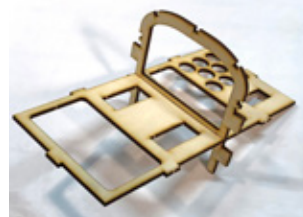

Step 77 - Fuselage Assembly (F3/F4 & FS2)

Locate FS2 from LP1 and the F3/F4 assembly from step 75.

The tabs in the F3/F4 assembly slide into pre-cut slots in FS2 as shown here.

Pay careful attention to the orientation of both pieces before gluing. F3 should face the firewall and it's rounded top should be opposite the wing saddle cutout in FS2.

Make sure the tabs are pushed COMPLETELY through FS2. The two parts should be securely against each other - no gaps - with F3/F4 at 90° when glued in place.



Step 78 - Fuselage Assembly (TR2 & FS2 assemblies)

Now it time to take both sub-assemblies and put them together as shown here. Make sure all tabs are fully seated in their matching pre-cut slots.

After test fitting, carefully separate, apply glue and hold everything firmly in position as the glue cures. Use clamps, or rubber bands if necessary.

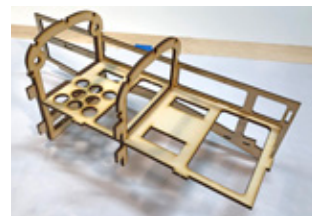

Step 79 - Fuselage Assembly (F6)

Locate F6 from LP1. It is glued in place on the back of this assembly as shown. Pay attention to the orientation and make sure all tabs are fully seated in their matching pre-cut slots while gluing.



Step 80 - Fuselage Assembly (TR1)

Locate TR1 from LP2. It is glued in place as shown. Note that TR1 has a small circle that designates the front, starboard side.

Pay attention to the orientation and make sure all tabs are fully seated in their matching pre-cut slots while gluing.



□ Step 81 - Fuselage Assembly (WH4)

Locate WH4 from LP2. WH4's notches fit into the two pre-cut slots in FS2, just above the wing saddle cutout.

Make sure the tabs are fully inserted into the fuse side. The two parts should be securely against each other - no gaps - with WH4 at 90° when glued in place.



□ Step 82 - Fuselage Assembly (FS1)

Locate FS1 from LP2. This is attached to the left side of the fuselage box assembly.

There are a lot of tabs and slots involved in getting this piece in place, so take your time and make sure all tabs are fully seated in FS1's matching pre-cut slots. Glue this in position, making sure there are no gaps between FS1, and the fuselage box.

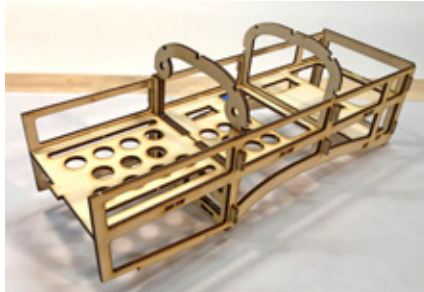

□ Step 83 - Fuselage Assembly (F2)

Locate F2 from LP3. This is glued in place to front the fuselage box. Make sure both fuselage sides are held in line with F2 along their entire length while the glue cures.

Also locate a couple pieces of scrap 3/16" square basswood. Cut two small pieces to reinforce the joint between F2 and the fuselage sides, acting as fillets. Glue these in place.



□ Step 84 - Fuselage Assembly (LG1 & LG3)

Locate LG1 and LG3 from LP1. These are both installed on the bottom of the fuselage box. LG3 is installed up-front, with its tabs inserted into F2's pre-cut slots. Note that it also has an etched circle designating the starboard side.

LG1 is installed into F3's pre-cut slots.

Makes sure both pieces are securely glued in place.

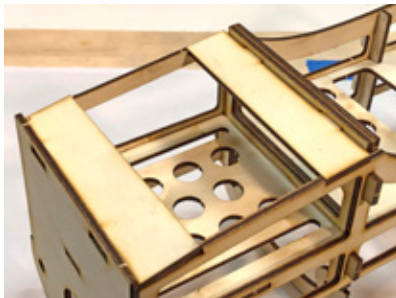

□ Step 85 - Fuselage Assembly (WH5)

Locate eight WH5 from LP1 and LP2.

These are glued on top of each other to make two equal stacks.

Then these two stacks are glued on top of the WH4, one on each side as shown.



□ Step 86 - Fuselage Assembly (fuse sides)

Locate both balsa fuselage sides from back in step 74.

These are now glued to the fuselage box as shown here.

The former's extended tabs will help you align these pieces. Make sure they are firmly and completely pushed up against the plywood box sides while the glue cures - no gaps. Note that the extended tabs on F4 and F5 will still extend past the fuselage sides - this is intended.



□ Step 87 - Fuselage Assembly (fuse sides.)

Once the glue has cured from the previous step, use some tape to carefully bring the rear edges of the fuselage together as shown here. Once aligned, lightly tape them together to aid in the following steps.

Notice the shape of the fuselage sides in this photo. During the next few steps, make sure the fuselage sides remains aligned like this. It will be easy to misalign this section to the left or right when gluing in the formers. If this happens, it won't be an easy thing to correct.

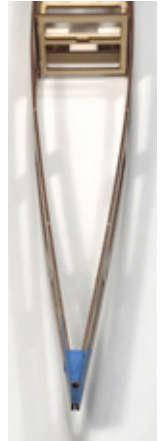

□ Step 88 - Fuselage Assembly (F7)

Locate F7 from BP7. Carefully insert it in place, with its tabs inserted into the pre-cut slots in the fuse sides. Make sure that the shorter wide cutout and round holes are aligned towards the top of the fuselage.

Glue in place



□ Step 89 - Fuselage Assembly (F8)

Locate F8 from BP7. Carefully insert it in place, with its tabs inserted into the pre-cut slots in the fuse sides. Make sure that center holes are aligned towards the top of the fuselage.

Glue in place.



□ Step 90 - Fuselage Assembly (TD4, TD5, TD6 & TD7)

Locate TD4, TD5, TD6 and TD7 from BP7. These sub-formers are the basis for the turtledeck. They are fitted in place in numerical order. Note to help in fitting them in place, the side-to-side fit is intentionally large (sloppy). This allows you to fit in one side, then gives you the clearance to slide it in slot on the other fuselage side.

Then center the piece between the sides as shown here. Make sure each TF is 90° to the fuselage side when gluing them in place.

Also take care as these pieces are



fragile, and will remain so until the stringers are attached in the next steps.

Step 91 - Fuselage Assembly (side stringers)

Locate two 1/8" square balsa sticks to form the side stringers. These will run from F3 back to F8, on the top of the fuselage side sheets.

Measure and cut them to length, then working from one end, slowly glue the strips in place, working a little at a time. Make sure the strip is fully inserted into the pre-cut slots in each former. This will allow the fuselage sides to be roughly 1/16" proud of the stringers, making room for the sheeting applied in future steps.



Step 92 - Fuselage Assembly (turtledeck stringers)

Using scrap 1/8" square balsa sticks first, measure and cut the three stringers for the turtledeck.

Glue these in place as shown, making sure they are fully inserted into the slots.



Step 93 - Fuselage Assembly (TD1)

Locate TD1 from BP6. This is the sub-former where the instrument panel (TD2) will be attached.

Refer to the plans as where this should be glued in place. This location isn't critical and can be moved a bit forward or rearward if desired. When you have a spot picked out, make sure it is aligned properly and 90° to the top of the fuselage sides while the glue cures.



Step 94 - Fuselage Assembly (front stringers)

Using scrap 1/8" square balsa sticks first, measure and cut the three stringers to run from F4 to TD1.

Glue these in place as shown, making sure they are fully inserted into the slots.



Step 95 - Fuselage Assembly (fin/stab)

Now locate the vertical fin and stab you constructed earlier. Take a few moments to round off a smooth radius, on each edge of both pieces, except for their trailing edges.

Test fit the fin into the stab, making sure it is firmly and completely pushed into the pre-cut slot in the center of the stab. Sand as necessary to get a good, slop-free fit.



Step 96 - Fuselage Assembly (fin/stab)

Remove the stab and cut two lengths of 1/4" square balsa scrap roughly 3-3/8" long.

These are glued in as stab supports, inside the fuselage sides and flush with the top edges.



Step 97 - Fuselage Assembly (fin/stab)

Remove the tape from the rear of the fuselage, and trial fit the stab on to the rear of the fuselage.

With it pushed into position as shown in this photo, place the fuselage on your building board and make sure that the stab is level with the building surface. Lightly sand the fuselage as necessary to level the stab.



Step 98 - Fuselage Assembly (fin/stab)

Now it's time to attach the fin and stab to the fuselage. First glue the vertical fin to the stab and make sure that the fin is 90° to stab's surface.

Then glue this assembly to the fuselage. Make sure that the stab is properly positioned, pushed up-against F8 and the long trailing edge of the vertical fin is between the fuselage sides. When properly positioned, the vertical fin should also be centered on the top, center stringer installed a few steps back.

Step 99 - Fuselage Assembly (fin/stab fillets)

Using two pieces of 1/4" x 1/2" scrap balsa, form two fillets that will go on each side of the vertical fin as shown here, outlined in black.

While these will provide a bit of stability to the vertical fin, they also allow the turtledeck to flow

into the fuselage in a way that's more pleasing to the eye. It'll take a bit of time to cut, trim and sand these so they continue the turtledeck's vertical and horizontal tapers into a point. When you've made matching left and right fillets, glue them in place.



Step 100 - Fuselage Assembly (elevator/rudder pushrods)

Before the bottom of the fuselage is sheeted, now is a good time to plan the route of the rudder and elevator pushrods through the rear of the fuselage.

We chose to use DuBro's flexible pushrod system in our prototypes, but use what works for you. If using a flexible pushrod system, you'll need to secure the outer tubing in a few spots to keep it from flexing. We've included several pre-cut holes in the rear formers to help "snake" and support those outer sleeves.

Step 101 - Fuselage Assembly (TW1/TW2)

Locate TW1 from LP1 and TW2 from LP2. These are glued together as shown here, centered and aligned on this single edge.

Then this assembly is attached to the bottom of the fuselage as

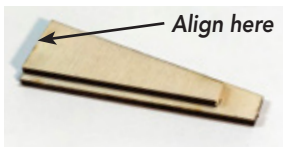

shown. You might need to trim a little of the trailing edge of the vertical fin to obtain a good fit. Glue in place when satisfied with the fit.



□ Step 102 - Fuselage Assembly (F6 support)

Using a length of scrap 1/8" square balsa, cut a length that will span across the bottom of F6, running between the fuselage sides. Glue this in position.



□ Step 103 - Fuselage Assembly (top sheeting)

Using pieces of 1/16" sheeting, it's now time to sheet the bottom of the fuselage. It will take two pieces to do this. Measure and cut two pieces, slightly oversized to form the sheeting of the fuselage top, between F3 and TD3 as shown here.



In order to get the balsa to easily bend, we recommend using Windex® glass cleaner to loosen up the grain. We found it best to do one half a time and using a hair dryer or covering heat-gun to help "set" the balsa's bend. Once dry, the you can glue it in position. Do the same for the other side.

□ Step 104 - Fuselage Assembly (fuse hatch framing)

Locate some scrap 1/8" square balsa, both H1's from LP2 and LP4, and a couple pieces of waxed paper. Cut two pieces of waxed paper to fit against the front and rear formers of the hatch area and press the H1's in position. Measure and cut the 1/8" square balsa to form the stringers that run between the H1 pieces. Glue the top three in position, then after the glue has cured, remove the hatch and glue in the bottom two to complete the framing.



□ Step 105 - Fuselage Assembly (fuse hatch sheeting)

Now use some 1/16th sheeting to sheet the hatch, using the same techniques as you did when sheeting the top of the fuselage a few steps back. When sheeted, sand the front and rear edges and test-fit into the fuselage to guarantee a good fit.



□ Step 106 - Fuselage Assembly (magnets)

Locate the eight magnets from the hardware bag. These are now installed into the pre-cut circles on both sides of the hatch, and into the pre-cut circles into the formers in the hatch area. Make sure they are pushed in so they are flush with the surfaces. A touch of thin CA will help hold them in place. And pay attention to their polarity so they attract, not repel.

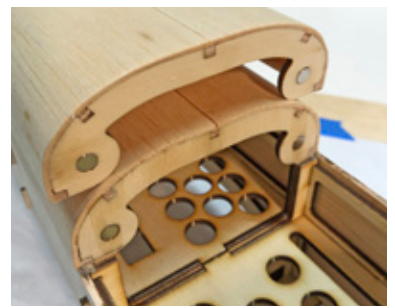

□ Step 107 - Fuselage Assembly (bottom sheeting)

Using pieces of 1/16" sheeting, it's now time to sheet the bottom of the fuselage. It will take several pieces to do this. Use the same edge-joining technique that use used when forming the sheeting for the center of the wings.



The sheeting should run from the front of TW1/TW2 assembly to the rear edge of the wing saddle. When finished, trim and sand the edges to they flow smoothly into the fuselage sides.

□ Step 108 - Fuselage Assembly (LG2 & LG4)

Locate LG2 and LG4 from LP2. These are glued to LG1 and LG3 on the underside of the fuselage (installed earlier). They will be flush with the fuselage sides and shown here.



□ Step 109 - Fuselage Assembly (LG5)

Locate LG5 from LP3.

This forms the floor, underneath the fuselage tray. Note the engraved circle designating the front, starboard corner.

Now you have an option here. You can either glue this in place now, or do what we've done and rely on the landing gear screws to hold it in position which gives you access to this area later on down the road. (We used this option to allow us to install and have access to the receiver battery in this area when using glow power. But with electric power, you'll likely not use this area at all, so gluing LP5 in place is fine. Again, your choice.



□ Step 110 - Fuselage Assembly (TD2 & TD3)

Locate TD2 and TD3 from BP9. These are both glued into the cockpit area. TD2 is the "instrument panel" and glued to the face of TD1.

TD3 is glued to the face of TD4 (shown here) forming the "headrest".

When properly positioned, both of these pieces will rest on the 1/8" strip on the cockpit sides, leaving a 1/16" gap around the outside edge - refer to the photo.



□ Step 111 - Fuselage Assembly (cockpit sheeting)

Using 1/16" balsa sheet, you'll now cut and form the pieces to dress-up the cockpit area.

You can choose to completely cover the cockpit, then cutout the opening, or make the opening cuts first, then install the pieces, as we've done here.

This is done in a similar manner to how you sheeted the top surfaces in previous steps - one half at a time, using Windex® to help bend the balsa as needed. The sheets will rest on the TD two pieces installed in the previous step to form a smooth surface with the other sheeting.



□ Step 112 - Fuselage Assembly (F1)

Locate F1 from LP3. Note It has an etched guide to help in the next steps. This surface should face forward when installing.

Mix up a bit of epoxy and glue F1 to the face of F2, making sure it is properly aligned. Clamp this in place to until the glue has cured.

These next steps are optional. If you prefer not to form the top of cowl area, it's up to you. If you're mounting a glow engine, depending on it's orientation it could be to your advantage to leave this area more open than usual.

We've included these steps to help those who want to dress-up their Sunday Fighter.

If you opt not to add this, move on to step 121.

□ Step 113 - Fuselage Assembly (N5)

Locate N5 from BP6. This is glued to F1 and we've included an etched guide on F1 to aid in aligning this piece correctly. It should leave a 1/16" gap around the top edge where sheeting will be applied.



□ Step 114 - Fuselage Assembly (nose length)

We've included some oversized pieces in these next couple of steps. The reason for this is you now have the option of building the nose as we've designed it, or you can shorten it to obtain a

different look and/or to work with the power system you choose to install. If you choose to shorten the nose, now is the time to cut equal lengths off both fuselage sides. Make any cuts equal in length and in angle.

□ Step 115 - Fuselage Assembly (N3)

Locate N3 from LP5. Note that it has very small steps cut into the sides. These steps should rest on the top of the fuselage sides. N3 is glued between the front edges of the fuselage sides as shown in the photo. Make sure N3 is aligned along it's length.



□ Step 116 - Fuselage Assembly (N4)

Locate N4 from LP5. As it is oversized, the sides will need to be trimmed so it fits as shown in the photo. flush with the bottom edge of the fuselage sides.

Glue this in place making N4 is aligned along the fuselage sides. When the glue has cured, cut away N3's cross brace.



□ Step 117 - Fuselage Assembly (nose stringers)

Locate scrap 1/8" square balsa strips to form the three stringers as shown here.

Measure, cut and glue these in position.



□ Step 118 - Fuselage Assembly (top nose sheeting)

Using 1/16" sheeting, now sheet the top of the cowl area as shown here.

Again do this in 3 pieces and use Windex® to aid in bending the balsa.



□ Step 119 - Fuselage Assembly (bottom nose sheeting)

This is another optional step. We chose to cover this area with our electric prototypes, but not in our glow powered versions.

If you choose to sheet the bottom of the cowl, use scrap 3/32" balsa sheet, cross-grained.



□ Step 120 - Fuselage Assembly (N1 & N2)

Locate both N1's and both N2's from BP8. These will be glued to the nose to give you a finished surface that can be easily sanded and rounded for a better look.

Glue one N1 to the front of fuselage, then trim one N2 to fit underneath it. Glue it in position as shown here. Do the same for the other N1 and N2 pieces.



Step 121 - Fuselage Assembly (center cabanes)

Locate both CB1's and CB2's from LP4. Also locate LP7 as you'll be using all of those pieces as well.

Place both CB1's on your work surface so they are mirror images of each other. This important as you need to make one left and one right cabane strut.



From LP7, locate one CB2B, CB2C and CB2D. These are laminated on top of each CB1. The parts will only fit correctly one way. Lightly rough the surface of each CB2B, C & D pieces with 100 grit sandpaper to give the glue a bit more to grip to. Now using epoxy, glue the pieces in place and be sure to keep epoxy out of the pre-cut slots and holes.

Clamp/weight-down these pieces to make a perfectly flat assembly. Do the same to make a mirror image center cabane.



When cured, now attach the CB2 on top using a bit more epoxy, again clamping/weighting it down as the glue cures.

Step 122 - Fuselage Assembly (center cabanes)

Lastly, each cabane will need a small taper filed/sanded in the outer surface. *The outer surface is CB2 - the one WITHOUT the rectangular cutouts.*

Just above the mounting holes, sand a bevel as shown here on each side. The bevel should start at the top of the mounting hole and gradually get a little deeper towards the top of the cabane assembly. It only needs to be partly through the top layer of plywood, so take care that you don't take off too much. These bevels will give the proper clearance for the top wing's mounting lugs.



Step 123 - Fuselage Assembly (outer struts)

Locate all CB3's from LP4/5/6 and CB4's from LP5/6. These are used to make the 8 outer struts. Two matching pieces are laminated together to form each outer strut. Tape, weight or clamp these pieces together so they'll stay perfectly aligned while the glue cures.

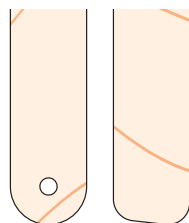

Note that there is a difference in the curvature on the ends of CB3 compared to CB4. The rounder profile are the forward struts and the more-squared profile, the aft struts.

Step 124 - Sanding (airframe)

Now is the time to get quite familiar with the sanding tools of your choice. Take the time to preform a good sanding, rounding each wing's leading edge and blending it into the wingtips. Go over the entire wing, making sure the sheeting is smooth and the trailing edges are blended, continuing the curvature of the wing. Smooth out the edges of the fuselage and the struts, but don't go too far.

For the control surfaces (elevator and rudder), sand bevels into the leading edges and round their trailing edges.

Step 125 - Fuselage Assembly (wing alignment)

To align the lower wing properly on the fuselage, place the lower wing in position, by pushing forward wing retainer into the slot cut into F3/F4. Lightly sand if necessary for a smooth fit.

Then allow the wing to rest in the wing saddle. The wing is perfectly aligned when the distance from the left wing tip to the rear of the fuselage is the same the distance when measured from the right wing tip.

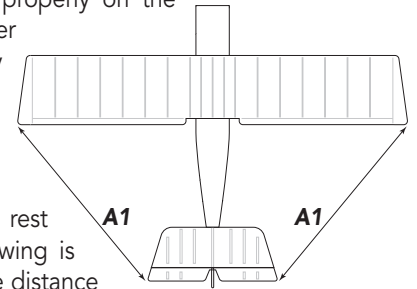

Step 126 - Fuselage Assembly (drill wing bolt holes)

With the wing aligned, drill two 3/16" holes for the wing bolts, using the pre-cut holes in each WH2 as a guide. Carefully push the bit down through WH2 before drilling. Once the bit is resting on the surface of the un-drilled WH1, then carefully drill through the wing and through all of the WH4/WH5's installed in the fuselage. Use caution to make sure the wing does not move until both holes are drilled.

When drilling, take your time and make sure the drill is held so the bit is perpendicular with the wing's sheeting. This will make it so the wing bolt goes in at an angle, but the screw's head will be flat on the wing surface.

Remove the drill, remove the wing and clean up around the new holes you drilled. Then run a 1/4x20 tap through the WH4/WH5 assembly so that the wing bolts will thread into this block. If you don't have access to a 1/4x20 tap, you can also use a 1/4x20 steel screw.

A few drops of thin CA will help strengthen and secure the threads you've cut after they've been tapped.

If you prefer, you can also use 1/4x20 t-nuts instead of threading into the wood (not included). To use these you will first have to enlarge the holes you just drilled to 1/4".

Step 127 - Fuselage Assembly (center cabanes)

Now it's time to glue the center cabanes to the fuselage. They are designed to only fit one way so you can't mix them up. Test fit them to the fuselage first, making sure they fit over the fuselage's extended tabs and seat firmly against the fuselage.

When satisfied with their fit,



remove them and glue them to the fuselage with a bit of epoxy. Clamp into position until the glue cures.

Step 128 - Main gear assembly (prep)

It's time to assemble the main landing gear. You'll find the front and rear pieces included in the kit.

Place the included nylon landing gear straps in position - 2 for the front, 2 for the rear. These straps are mounted to front and rear of LG5.

Position the gear strut wires similarly to how we show in the following photo, then mark and drill 1/16" holes where the straps should mount, then attach them using the supplied 2-56x3/4" self tapping screws.

Step 129 - Main Gear Assembly (soldering)

With the gear pieces mounted, rotate the rear wire so it is roughly perpendicular to the fuselage. Then rotate the front wire so the angled ends meet the rear wire. Both pieces of wire need to be lightly sanded and



cleaned where the wires touch, both on the left and right side. After cleaning, carefully and tightly wrap this joint with wire as shown here using. We used 26 gauge wire, but other thicknesses can be used.

Starting on one side, lightly brush on a bit of flux over the entire wire-wrap, then use a small torch (or a soldering iron) to securely solder the wire wrap in position, securing the front and rear landing gear wires into a solid, one piece unit.

When finished, do the same to the other side of the gear and you should have something like this when finished.

Step 130 - Top wing test fit (center cabanes)

With the main gear attached, re-attach the bottom wing. Now it's time to test fit the top wing. You'll need the eight outer struts, the twenty 4-40x1/2 bolts and the twenty 4-40 t-nuts.

First position the top wing on the center cabanes. The straps in the top wing should be on the outside edges of each cabane, where you sanded bevels earlier. Push a 4-40x1/2 bolt through each of the four mounting lugs and through the pre-cut holes in the cabanes.

Then thread 4-40 t-nuts on to each of these bolts. Slowly tighten the bolts and seat each of the t-nuts teeth into the cabane. They are properly seated when the flat of the t-nut is up-against the wood of the cabane. Do not over-tighten as you can crush the wood or strip the t-nut(s).

Step 131 - Top wing test fit (outer struts)

With the wing attached to the center cabanes, now install the outer struts, keeping in mind the rounded struts are forward and the more squared-off struts are aft. Again use 4-40x1/2 bolts and t-nuts to secure the struts to the bottom, then top of the wings. You might need to use a slight bit of pressure to align the mounting holes, but only slight. If you need to use excessive force it means that you might have built a warp into the wing and/or not aligned the root ribs properly when building the wings.

We've found that attaching the struts to the lower wing first works

best. These struts should be positioned on the outside of the metal straps, with the bolt running through the strap first, then into the strut, and finally the t-nut.

The top wings should have the struts on the inside of the metal straps.

When satisfied with the fit and you're sure the t-nuts are all seated properly, remove both wings and all the struts. Use a touch of glue around the perimeter of the back of each t-nut to hold it in place. Make sure not to get any glue into the threads.

Step 132 - Tailwheel mounting

Mount your choice of tailwheel to the bottom of the fuselage. It should mount to the bottom of the plywood TW assembly, already installed.

We chose to use a simple wire tailwheel that mounts into the rudder. If going this route, make sure it's in place before hinging and mounting the rudder to the fuselage.

Step 133 - Ailerons

The ailerons are on BP3. A1s are the lower ailerons, A2 the upper ailerons.

Your Sunday Fighter can be built with either 3 (throttle, rudder & elevator) control, or 4 channel (adding ailerons). We prefer ailerons as it gives another level of control in the rolling axis, but the purists out there might prefer otherwise.

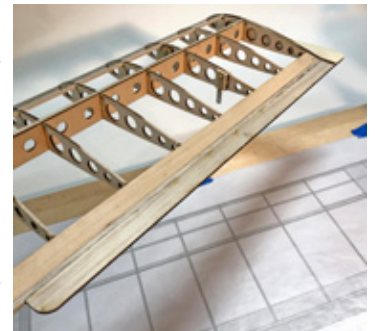

We find that the Sunday Fighter works just fine with ailerons only on the lower wing. But, at this point you also have the option to use ailerons on both upper and lower wings.

If you choose lower ailerons only, you'll need to glue one ALL strip to the trailing edge of the top wing as shown, on each side. The flat edge should rest against the wing tip.

Make sure these are securely glued and properly aligned along their entire length.

If you choose to use upper ailerons as well, you'll need to get a few things at your local hobby shop as we don't include them. You'll need another set of aileron hinges for each top aileron, four control horns, two 1/16" rods that are a minimum of 8 inches long with a threads cut into one end, and a couple of clevises.

The control horns will mount to the top of the lower ailerons and the bottom of the upper ailerons, in line vertically. They should also be roughly mid-way along the aileron's span.

Then mount the pushrods and clevises to link both ailerons together. Use the threaded end for the bottom and bend a z-bend for the top.

Now it's time to think about radio and engine installation.

These next steps of covering, hinging, radio and power installation are not in any particular order. Some modelers like to cover everything first, then outfit the rest. Others like to hinge and pre-install the components, working out the installation before covering. Use the method that works best for you.

We prefer to pre-install many of the components to make sure there are no surprises in the way things fit or might have to be modified for after market items. We find it much easier to fix these problems now, before covering, as there's nothing worse than ruining a good covering job by having to hack a hole or provide clearance for something.

Aileron servo hatches

If you choose to use ailerons, locate the servo hatches and note the etched arrows in each. This arrow signifies the leading edge of the wing. Note that the left hatch is a mirror image of the right hatch. Position your aileron servo on the inside of the aileron hatch so the servo arm output shaft is centered in the opening.



From leftover basswood strip, cut and stack pieces to create servo posts. Make a mounting post by laminating two or three pieces together. Make 3 additional posts from the remaining pieces, sanding the ends of all 4 posts flat.

On the inside of each aileron hatch, glue one post on each side of the servo as shown in the previous photo.

Now attach the servos by drilling 1/16" holes through the servos mounting lugs, then using the servos mounting hardware to attach them to the hatches.

Aileron wire holes for servo wires

On the plans you'll see callouts where the two holes should be cut in the bottom wing's center sheeting. These holes are only on the top side and allow the aileron servo wires to pass through the wing and into the fuselage. Mark and cut these holes with a sharp hobby knife.

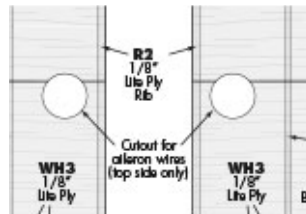

Pushrods (rudder & elevator)

In F7 and F8 we've made provisions to help you run flexible pushrods back through the fuselage. You'll see a pair of pre-cut holes where you can snake the outside of the flexible tubing system of your choice, then continue out through the exit holes pre-cut in the sides of the fuselage.

If you choose to use this type of pushrod, make sure you glue this outer sleeve to each of these center supports. If you choose a different system, these supports can be cut away as needed for clearance.

Make sure that when installing the control horns, they are placed in-line with the pushrods, and that the line of holes where the clevises attach are positioned over the hinge line.

For the average pilot, we recommend that clevises are attached to the outermost hole on each control horn.

Servo mounting (rudder & elevator)

The rudder and elevator servo should be mounted in the two rectangular holes pre-cut in the back of TR2.

From scrap 1/8" lite ply, cut four strips to double-up the wood where the servo mounting screws will be install.

Servo mounting (throttle - glow engines)

If you are powering your Sunday Fighter with a glow engine, then you'll also need to mount a throttle servo into the forward hole in TR2.

Radio installation

Finish the installation of your radio gear by adding the receiver, flight pack battery and the switch. We mounted the receiver using a bit of self-adhesive hook-and-loop (not included).

If you're using a flight pack battery, there is no set place to install it. It's location should be dictated more by the C.G. than anything else. As we mentioned before, when we used a flight pack

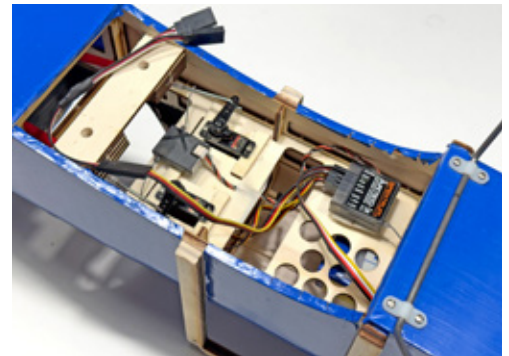

battery with our glow-powered prototypes, we chose to mount it in the space between TR1 and LG5.

Also any switches (whether radio or arming for the electric power system) can be mounted in the tank/battery compartment. The magnetic hatch is quickly released to get to them.

Power system

Installing your power system of choice is up next. We'll show photos for regarding electric and glow installations. Note that these are suggestions only as your power system might vary from what's shown here.

Glow power

Your engine mounts so the crankshaft is positioned over the center of the circular cutout on the firewall. It can be mounted upright, side or even inverted. We chose side mounting it as shown here with a "Pitts-style" muffler as it worked best in our prototypes. Mounting the engine using a regular muffler typically requires a muffler extension to move the muffler far enough out to clear the fuselage side.



Holes will also need be drilled for the throttle pushrod to pass through into the fuselage.

You'll also need to install a fuel tank, which rests in the compartment behind the firewall, on TR1. We used a bit of hook-and-loop tape to hold the tank in position as shown here.



Electric power

When mounting an electric motor, we have provided a motor spacer box that can be used. Note that it is not universal but has worked with the motors we've tried.

This box consists of the parts from LP6. M1 is the base as shown in this photo, then the M3's make up the sides, and M2 the top.



Before gluing these pieces together, drill M2 to accept your motor's mounting bracket, then attach t-nuts (not included) on the back side of M2. When that's worked out, you can then glue it all together, mount your motor and then mount it to the firewall.

To mount to the firewall, we simply epoxied it in place. To align it properly, orientate the fuselage vertically, with the firewall facing up. Then test fit the motor box in position. Because of the built in right and down thrust of the firewall, you'll need to have the motor box slightly off-center to allow the prop shaft to "appear" to be centered in the front of the cowl opening.

Also, cooling holes will need be added into the fuselage to help cool your batteries. We've designed in 5 precut slots on the side of the fuselage to help with this. These work along with the included molded louvers to help "scoop" air into the fuselage.

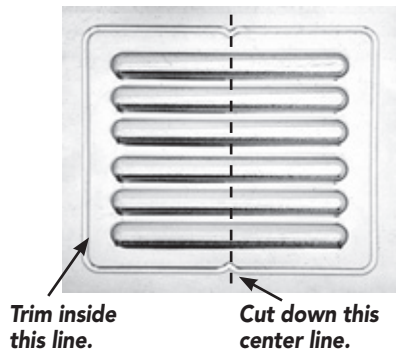

Cut the molded louver right down the middle with a sharp set of shears. You'll see a couple of molded-in marks to help show where to cut.

These pieces can be left clear or painted to match your covering, then glued in place over the fuselage side cutouts with some canopy glue, after your covering has been applied.

Covering

Now it is time to cover the Sunday Fighter. Remove the powerplant, main gear, tailwheel, pushrods, and any other components that would get in the way of applying the covering.

Double check that all surfaces are smooth and ready to cover. Sand as necessary, then cover the entire airframe with the covering/finish of your choice.

Note that if you're powering with an electric motor, you'll need to make a hole for the cooling air to escape the bottom of the fuselage, near the rear.

When the covering is complete, re-attach all the components you removed earlier in this step.

Logos, numbers, etc.

If you want to use graphics similar to the ones we used, we highly recommend Callie Graphics as a supplier for pre-cut vinyl. They are a very well known provider of custom graphics for R/C models. We don't have a specific graphic set for the Sunday fighters, as they are using existing markings.

Contact Callie Graphics at this link: <https://callie-graphics.com> or scan the QR code.



Note that Callie Graphics is not affiliated with Old School Model Works, nor does Old School Model Works generate any income from this partnership.

Attach the Control Surfaces

Now is the time to attach all the control surfaces to the airframe, by gluing the hinges in position with thin C/A.

Make sure that you attach the elevator first, then the rudder. Also note that the tailwheel assembly should be in place before the rudder is attached.

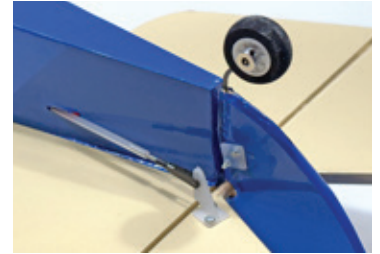

Attach wheels

Use the included 1/8" i.d. wheel collars to hold each wheel (not included) on the axles. For a maintenance free installation, file a small flat on the axle where the set screw of the wheel collar touches. Also use a touch of thread-locking compound to keep the screw from loosening over time.

Finishing details (windscreen - optional)

We've included a molded windscreen. This piece is a bit oversized, but it allows you to be a bit creative and leave as-is, or cut it down to a more rectangular, smaller, or even narrower shape. Glue in place in front of the pilot with a bit of canopy glue.



Finishing details (pilot - optional)

If you'd like a pilot figure to upgrade the cockpit of your Barnstormer, consider purchasing one of our Cranky Cockpit Club pilot figures. We have 30+ pilot figures, available in 1/8 to 1/3 scale. For complete info on these pilots and to order you own, visit <https://www.oldschoolmodels.com/ccp-pilots.htm> or scan this QR code.



This completes the assembly of the Sunday Fighter. Now you'll need to adjust the control throws and check for balance.

CAUTION! DO NOT SKIP THIS STEP!

The recommended Center of Gravity (CG) location for the Sunday Fighter is measured back 2.3" from the leading edge of the top wing, and you'll see this marked on the fuselage plan with this symbol.

C.G. BALANCE POINT



If necessary, move the battery, receiver, and/or add weight to either the nose or the tail until the correct balance is achieved. Stick-on weights are available at your local hobby store and work well for this purpose.

Recommended Control Throws:

The amount of control throw should be adjusted as closely as possible using mechanical means, rather than making large changes electronically at the radio.

By moving the position of the clevis at the control horn toward the outermost hole, you will decrease the amount of control throw of the control surface. Moving it toward the control surface will increase the amount of throw. Moving the pushrod wire at the servo arm will have the opposite effect: Moving it closer to center will decrease throw, and away from center will increase throw. Work with a combination of the two to achieve the closest or exact control throws listed.

Aileron 1/2" up/down (25% expo)
Elevator 5/8" up/down (20% expo)
Rudder 1" left/right (15% expo)

We found than aileron/rudder mix worked well - 25% or so to start.

(Expert tip: Once the control throws have been set, cut a few pieces of medium silicone fuel tubing (or heat shrink tubing) to go around each of the clevises. This will keep them from opening during flight.)

Preflight:

Charge both the transmitter and receiver pack for your airplane. Use the recommended charger supplied with your particular radio system, following the instructions provided with the radio. In most cases, the radio should be charged the night before going out flying. Check the radio installation and make sure all the control surfaces are moving correctly (i.e. the correct direction and with the recommended throws). Test run the engine and make sure it transitions smoothly from idle to full throttle and back. Also ensure the engine is tuned according to the manufacturer's instructions, and it will run consistently and constantly at full throttle when adjusted.

Check all the control horns, servo horns and clevises to make sure they are secure and in good condition. Replace any items that would be considered questionable. Failure of any of these components in flight would mean the loss of your aircraft.

Range check your radio before flying

Before each flying session, range check your radio. This is accomplished by turning on your transmitter with the antenna collapsed. Turn on the radio in your airplane, but do not attach the arming switch.

With your airplane on the ground, you should be able to walk 30 paces away from your airplane and still have complete control of all functions. If not, don't attempt to fly! Have your radio equipment checked out by the manufacturer.

A note about flying the Barnstormer

At the start, we thought that the Barnstormer would fly quite similarly to our other Sunday Fighters (the Bristol Spadport and the Heinschmitt). But after putting in a lot of time perfecting this design, to our surprise we found it to be far less Fighter and more of a Cruiser - it flies similarly to a full-scale Curtiss Jenny. You can do loops, wingovers, and hammerheads with a gentle dive. Rolls and snaps really just aren't the Barnstormer's thing - but the same can be said of the full-scale Jenny. And thanks to its larger wing area and extra drag, the Barnstormer can slow down a bit more than our original Sunday Fighter biplanes, which makes for more relaxed flying.

Warranty Information

Old School Model Works guarantees this kit to be free from defects in both material and workmanship at the date of purchase. This warranty does not cover any parts damage by use or modification. In no case shall **Old School Model Works'** liability exceed the original cost of the purchased kit. If you find any damaged or missing parts, contact us within 30 days from purchase to receive replacement(s).

Further, **Old School Model Works** reserves the right to change or modify this warranty without notice.

In that **Old School Model Works** has no control over the final assembly or material used for the final assembly, no liability shall be assumed nor accepted for any damage of the final user-assembled product. By the act of using the product, the user accepts all resulting liability.

Limit of Liability

In the use of this product, our only obligation shall be to replace such quantity of the product proven to be defective. The user shall determine the suitability of the product for his or her intended use and shall assume all risk and liability in connection therewith.

If the buyer is not prepared to accept the liability associated with the use of this product, the buyer is advised to return this kit immediately in new and un-opened condition.

As of this printing, you are required to register with the FAA if you own this product. For up-to-date information on how to register with the FAA, visit <https://registermyuas.faa.gov>. For additional assistance on regulations and guidance of UAS usage, visit <http://www.knowbeforeyoufly.org>.



This manual is © Copyright 2026, Old School Model Works. All Rights Reserved.

For more information on all of our other products, as well as the latest news from Old School Model Works:

Please check out our website: www.oldschoolmodels.com

You can reach us on Facebook:
www.facebook.com/oldschoolmodelworks

Instagram: www.instagram.com/oldschoolmodelworks/

See photos of our kits and customer builds on Flickr:
<http://www.flickr.com/photos/oldschoolmodelworks/>

LP1
1/8" Lite Ply

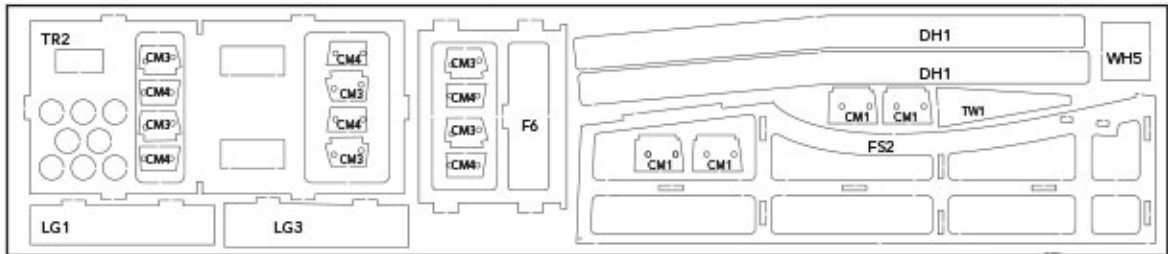

LP2
1/8" Lite Ply

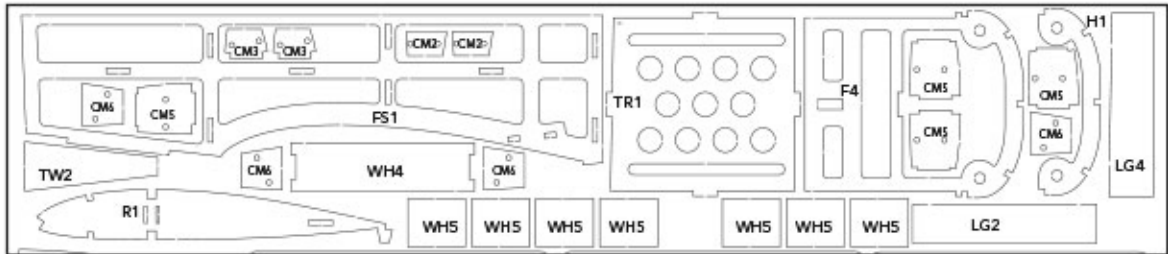

LP3
1/8" Lite Ply

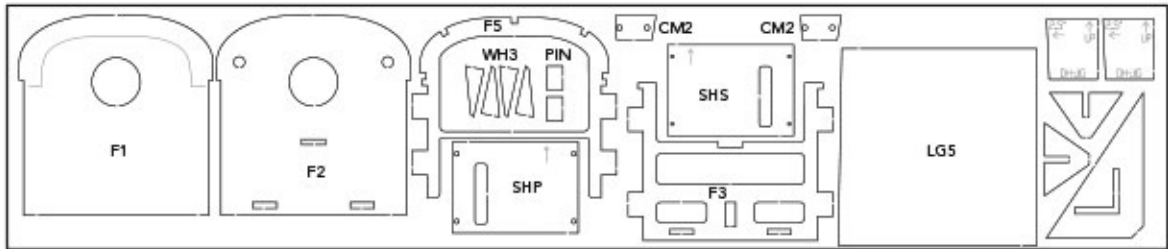

LP4
1/8" Lite Ply

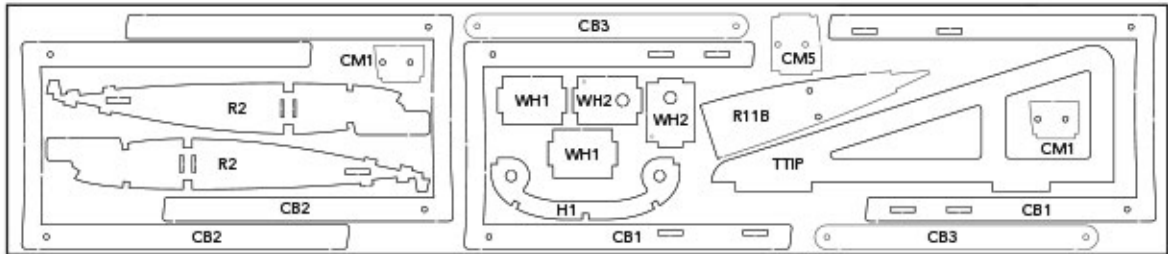

LP5
1/8" Lite Ply

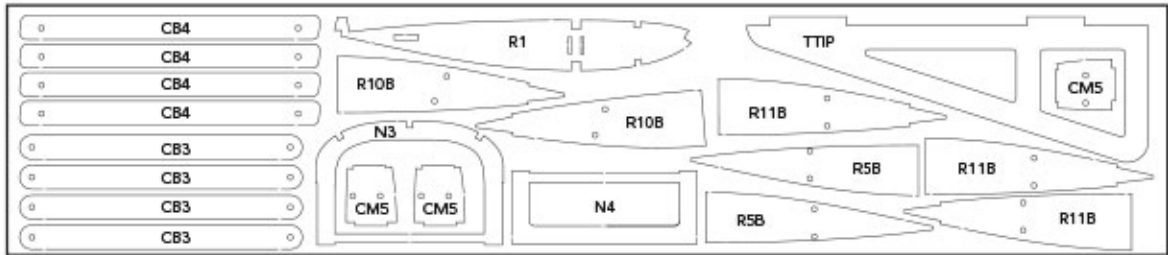

LP7
1/16" Ply

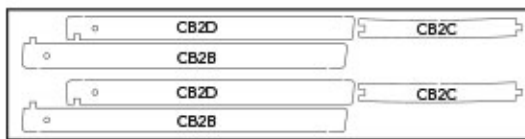

LP6
1/8" Lite Ply

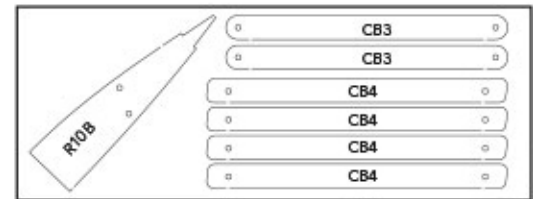

LP8
1/8" Lite Ply

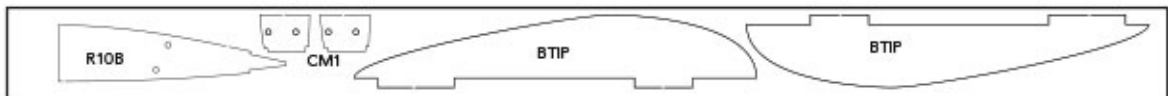

LP9
1/8" Lite Ply

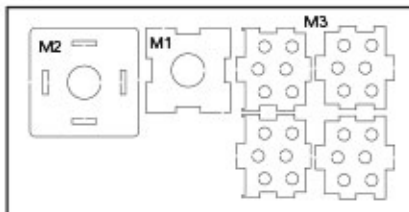

BP10
1/16" Balsa

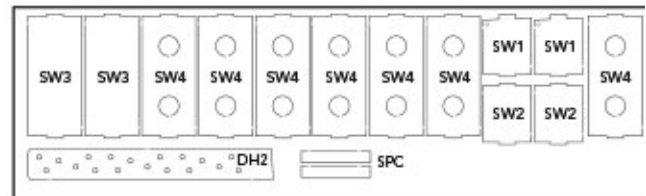

BP1

1/8" Balsa

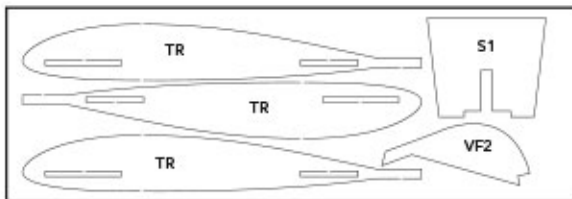

BP2

1/8" Balsa

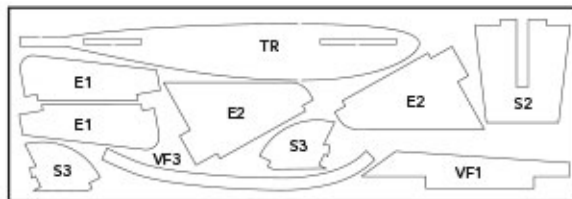

BP3

1/8" Balsa

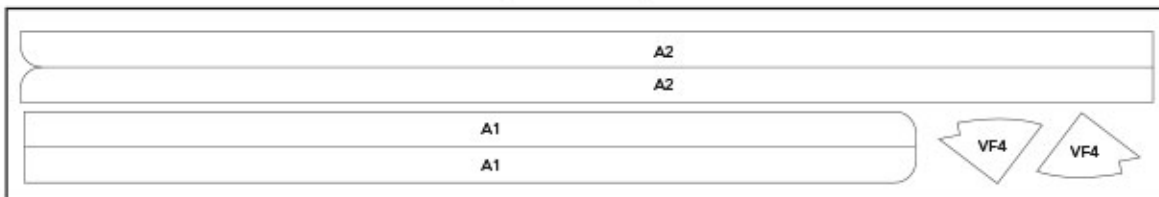

BP4

3/32" Balsa

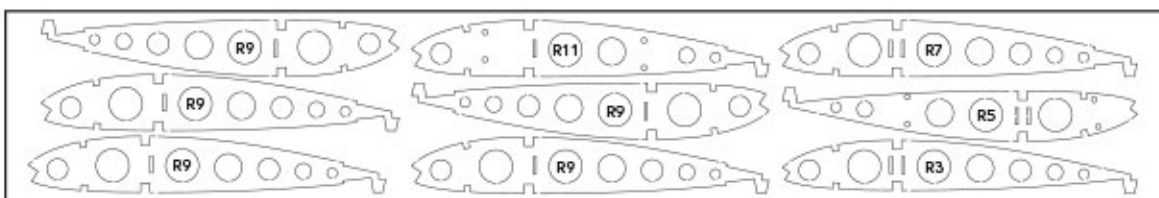

BP5

3/32" Balsa

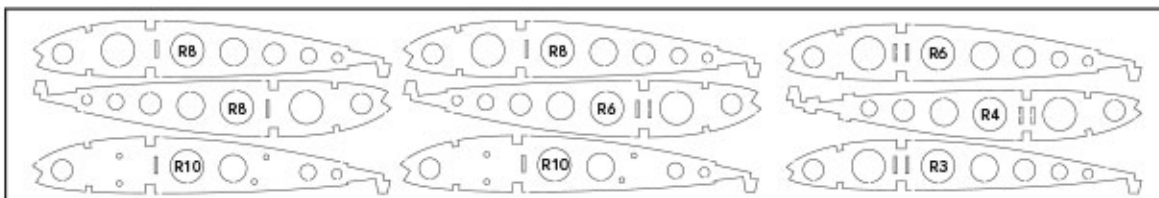

BP6

3/32" Balsa

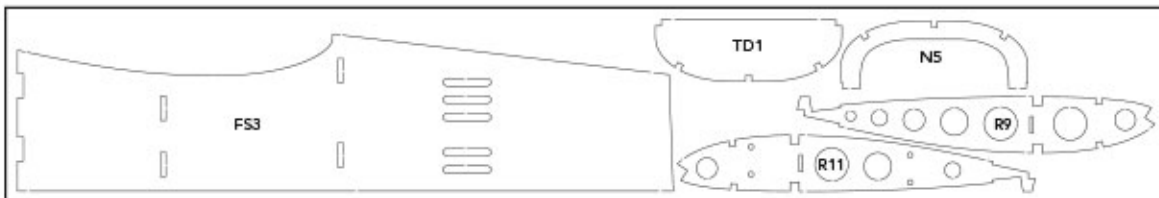

BP7

3/32" Balsa

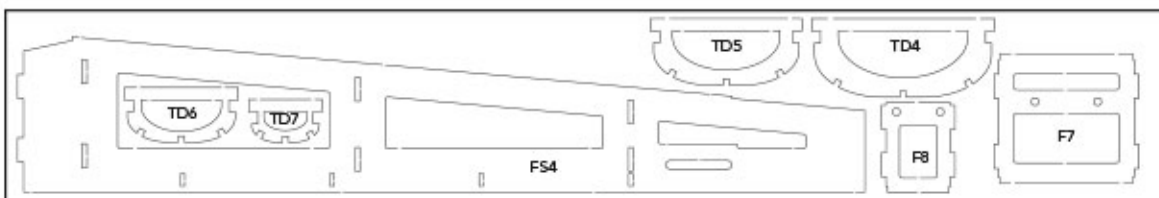

BP8

3/32" Balsa

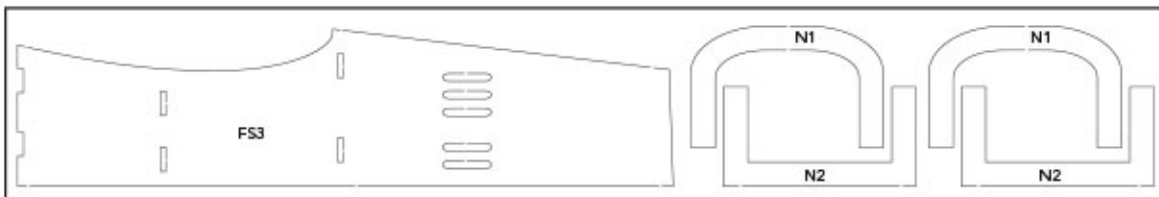

BP9

3/32" Balsa

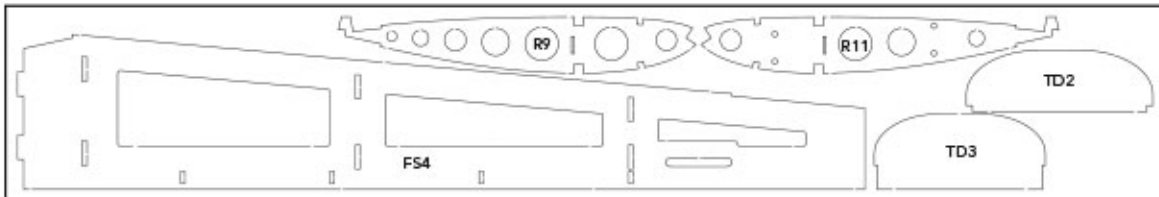

BP11

1/16" Balsa

